

CORNER BASKET BA260

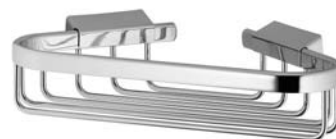

220 x 47 x 160 mm

- Corner basket in chrome-plated brass.
- Solid edge and 4 mm thick wires.
- Concealed anti-theft wall mountings.
- Mounting: With four screws.
- Delivery includes fixing material.
- Weight, including single package: 0.5 kg



Suggested text for specifications:

Corner basket in chrome-plated brass. Solid edge and 4 mm thick wires. Concealed anti-theft wall mountings. Delivery includes fixing material.

Dimensions: 220 x 47 x 160 mm

Article No. BA260

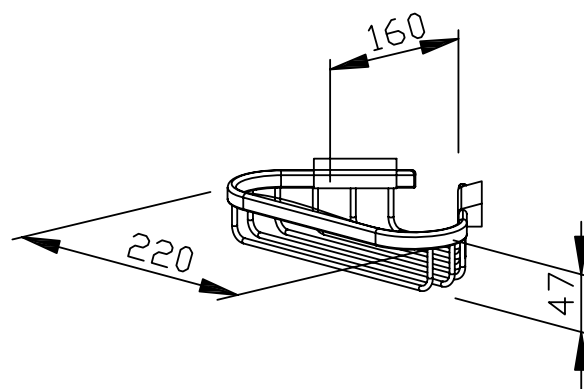

Available surface	ID No.
Chrome-plated brass	600 260

Ernst Wagner GmbH & Co. KG

Ernst-Abbe-Straße 21 · D-72770 Reutlingen · Tel.: +49712151539-0 · Fax: -20
info@wagner-ewar.de · www.wagner-ewar.de

WAGNER
E W A R