

Cajas de bornas

Gama de ABS

Caja para bornas grande | OABP

IP 66,67 | IK 06/07



Descripción:

Caja de ABS, libre de halógenos, adecuada para uso interior. Baja resistencia a rayos UV.

Material:

ABS.

Junta:

Junta de poliuretano integrada en la tapa de la caja.

Resistencia a la temperatura:

-40 °C a +60 °C.

Inflamabilidad:

UL94 HB.

Protección:

IP 66/67 | IK 06 (-25°C), IK 07 (+35°C).

Acabado:

RAL 7035.

Certificaciones:

CE, GOST.

Suministro:

Base de la caja, tapa, tornillos de poliamida para la tapa y tornillos de montaje.



IP 66,67 | IK 06/07

Con tapa gris

| Dimensión de la caja | | | Profundidad interior (mm) | Ref. |
|----------------------|-----|-----|---------------------------|--------------|
| A | An | P | | |
| 200 | 200 | 132 | 115 | OABP202013GE |
| 200 | 300 | 132 | 115 | OABP203013GE |
| 200 | 400 | 132 | 115 | OABP204013GE |
| 300 | 300 | 132 | 115 | OABP303013GE |
| 300 | 400 | 132 | 115 | OABP304013GE |
| 300 | 600 | 132 | 115 | OABP306013GE |
| 400 | 600 | 132 | 115 | OABP406013GE |

Con tapa transparente

| Dimensión de la caja | | | Profundidad interior (mm) | Ref. |
|----------------------|-----|-----|---------------------------|--------------|
| A | An | P | | |
| 200 | 200 | 132 | 115 | OABP202013TE |
| 200 | 300 | 132 | 115 | OABP203013TE |
| 200 | 400 | 132 | 115 | OABP204013TE |
| 300 | 300 | 132 | 115 | OABP303013TE |
| 300 | 400 | 132 | 115 | OABP304013TE |
| 300 | 600 | 132 | 115 | OABP306013TE |
| 400 | 600 | 132 | 115 | OABP406013TE |

Plano de dimensiones | OABP

Vista frontal

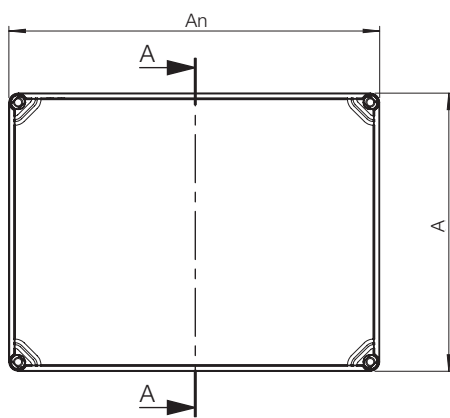

Vista seccional lateral

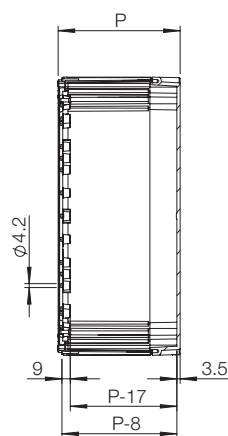

SECCIÓN A-A



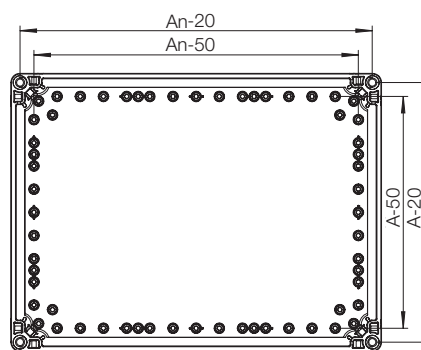

Inside box view

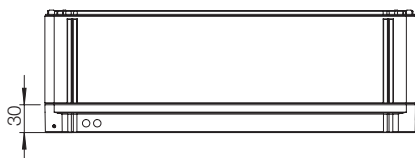



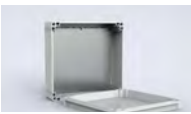

Vista superior



Matriz de selección de accesorios | OABP

| | | | |  |  |  |  |
|--------------|------|-------|-----|---|---|--|---|
| Caja | | | | Montaje | | | Fijación |
| | Alt. | Anch. | P | Placa de montaje | Kit de ajuste de profundidad de la placa de montaje | Carril DIN | Soportes de montaje mural |
| OABP202013GE | 200 | 200 | 132 | OMP2020E | OELA1.04E | DR351505E | OFL1E |
| OABP203013GE | 200 | 300 | 132 | OMP2030E | OELA1.04E | DR351505E/DR352505E | OFL1E |
| OABP204013GE | 200 | 400 | 132 | OMP2040E | OELA1.04E | DR351505E/DR353505E | OFL1E |
| OABP303013GE | 300 | 300 | 132 | OMP3030E | OELA1.04E | DR352505E | OFL1E |
| OABP304013GE | 300 | 400 | 132 | OMP3040E | OELA1.04E | DR352505E/DR353505E | OFL1E |
| OABP306013GE | 300 | 600 | 132 | OMP3060E | OELA1.04E | DR352505E | OFL1E |
| OABP406013GE | 400 | 600 | 132 | OMP4060E | OELA1.04E | DR353505E | OFL1E |
| OABP202013TE | 200 | 200 | 132 | OMP2020E | OELA1.04E | DR351505E | OFL1E |
| OABP203013TE | 200 | 300 | 132 | OMP2030E | OELA1.04E | DR351505E/DR352505E | OFL1E |
| OABP204013TE | 200 | 400 | 132 | OMP2040E | OELA1.04E | DR351505E/DR353505E | OFL1E |
| OABP303013TE | 300 | 300 | 132 | OMP3030E | OELA1.04E | DR352505E | OFL1E |
| OABP304013TE | 300 | 400 | 132 | OMP3040E | OELA1.04E | DR352505E/DR353505E | OFL1E |
| OABP306013TE | 300 | 600 | 132 | OMP3060E | OELA1.04E | DR352505E | OFL1E |
| OABP406013TE | 400 | 600 | 132 | OMP4060E | OELA1.04E | DR353505E | OFL1E |

| | | | |  |  |  |  |
|--------------|------|-------|-----|---|---|--|---|
| Caja | | | | Cubierta | | | Fijación |
| | Alt. | Anch. | P | Bisagras | Tapones | Tornillo de mariposa | Marco de extensión |
| OABP202013GE | 200 | 200 | 132 | OHI1E | OCP1E | OLW55E | OPCP202006EE |
| OABP203013GE | 200 | 300 | 132 | OHI1E | OCP1E | OLW55E | OPCP203006EE |
| OABP204013GE | 200 | 400 | 132 | OHI1E | OCP1E | OLW55E | OPCP204006EE |
| OABP303013GE | 300 | 300 | 132 | OHI1E | OCP1E | OLW55E | OPCP303006EE |
| OABP304013GE | 300 | 400 | 132 | OHI1E | OCP1E | OLW55E | OPCP304006EE |
| OABP306013GE | 300 | 600 | 132 | OHI1E | OCP1E | OLW55E | OPCP306006EE |
| OABP406013GE | 400 | 600 | 132 | OHI1E | OCP1E | OLW55E | OPCP406006EE |
| OABP202013TE | 200 | 200 | 132 | OHI1E | OCP1E | OLW55E | OPCP202006EE |
| OABP203013TE | 200 | 300 | 132 | OHI1E | OCP1E | OLW55E | OPCP203006EE |
| OABP204013TE | 200 | 400 | 132 | OHI1E | OCP1E | OLW55E | OPCP204006EE |
| OABP303013TE | 300 | 300 | 132 | OHI1E | OCP1E | OLW55E | OPCP303006EE |
| OABP304013TE | 300 | 400 | 132 | OHI1E | OCP1E | OLW55E | OPCP304006EE |
| OABP306013TE | 300 | 600 | 132 | OHI1E | OCP1E | OLW55E | OPCP306006EE |
| OABP406013TE | 400 | 600 | 132 | OHI1E | OCP1E | OLW55E | OPCP406006EE |